

CUBE-iT™ Wall-Mount Cabinet

CUBE-iT™ Wall-Mount Cabinet provides a secure, easy-to-install, swing-out storage solution for information and communications technology (ICT) equipment. Attractive design, security features and range of optional fan kits make it ideal for public areas or equipment rooms with limited floor space.



ADVANTAGES

- ➔ **Easy Access to Equipment**
 - Three-part, swing-out design enables easy access to the front and rear of installed equipment
- ➔ **Modern, Sleek Design**
 - Attractive design with multiple door styles and colors make it suitable for use in public areas outside of telecommunications rooms
 - Low-decibel, dual-fan kit option provides quiet operation while keeping active equipment cool
- ➔ **Retrofit Capability**
 - Removable top and bottom rear panels with a rectangular knockout are perfect for retrofit deployments over existing equipment and cabling
- ➔ **Increased Security**
 - A single lock and key on the front door provides access to the cabinet; the rear section is only accessible via an internal latch inside the front door
- ➔ **High Load Rating**
 - 300 lb (136 kg) UL 2416 Listed load rating supports heavier equipment
- ➔ **Cable Management Features and Options**
 - A host of optional cable management accessories help keep cables neat and organized

KEY FEATURES

- Three-part, swing-out design allows access and service to the front and rear of equipment
- A single lock and key (CH751) on the front door provides access to the entire cabinet
- Rear panel includes 1" (25.4 mm) and 3" (76 mm) knockouts, and can accept 3/4" (19 mm) and 2.5" (63.5 mm) conduit. The 3" (76 mm) knockouts include edge-protection grommets
- Rear panel features cable tie and attachment points for accessory rack-mount brackets
- UL® 2416 Listed, 300 lb (136 kg) load rating
- Internal latch mechanism secures the rear panel; slim-profile does not impact cabling space
- Hinge design allows the installer to remove the rear panel for easier installation on the wall
- Cabinet body includes one pair of adjustable depth 19" EIA threaded equipment mounting rails
- Cable pass-through knockout with optional brush seal makes it ideal for retrofit installations
- Optional low-decibel (31 dB), dual-fan kit provides quiet operation while cooling equipment
- Factory-prepped bonding feature provides convenience and reduces installation time
- Ships fully assembled

SPECIFICATIONS

Description	Wall-mount enclosure with lockable front door and swing-out rear access to equipment
Use	For indoor use only, in environmentally controlled areas; may not be used outdoors, in harsh environments, or in air-handling spaces
Available Sizes	<ul style="list-style-type: none"> • Heights: 24" (610 mm), 36" (910 mm) and 48" (1220 mm) • Widths: 24" (610 mm); 19" EIA rack-mount • Depths: 18" (460 mm), 24" (610 mm), 30" (760 mm)
Usable Interior Space	<ul style="list-style-type: none"> • Heights: 12U, 19U, 26U • Widths: 19" EIA rack-mount • Depths: refer to dimensional drawings on page 2
Cable Access	<ul style="list-style-type: none"> • (8) 1" (25.4 mm) and 3" (76 mm) knockouts, 4 top/4 bottom. Knockouts can accept 3/4" (19 mm) or 2.5" (63.5 mm) conduit • (4) Edge-protection grommets are included for the 3" (76 mm) knockouts • Removable top/bottom panel on rear panel *Can't remove while under load; must remove center chassis • (1) Rectangular knockout, 9"W x 2.2"D (230 mm x 55 mm)
Equipment Support	<ul style="list-style-type: none"> (1) Pair L-shaped equipment mounting rails in the main cabinet body • 19"W, EIA-310-D compliant • Universal hole pattern, 5/8"-5/8"-1/2" vertical hole spacing • Threaded #12-24 equipment mounting holes • 5"D (130 mm) rear panel punched to accept accessory equipment mounting brackets, see dimensional drawings on page 2 • Includes 50 each #12-24 equipment mounting screw

Global Availability

US & Canada

+1-800-834-4969
 Toronto, Ontario, Canada
 +905-850-7770
 chatsworth.com
 techsupport@chatsworth.com

Latin America

+52-55-5203-7525
 Toll Free within Mexico
 01-800-01-7592
 chatsworth.com.co

Europe

+44-1628-524-834
 chatsworth.com

Middle East & Africa

Dubai, UAE
 +971-4-2602125
 chatsworth.ae

Asia Pacific

+86 21 6880-0266
 chatsworth.com.cn



CHATSWORTH
 PRODUCTS

SPECIFICATIONS

Load Capacity	300 lbs (136 kg) of equipment, open or closed
Certifications	<ul style="list-style-type: none"> • UL-2416 • cUL CSA C22.2 • UL 508A: Type 1 • NEMA Type 1 • IEC 60529 IP20
Material	<ul style="list-style-type: none"> • Steel sheet cabinet body, rear panel and door • Door is extruded metal frame with solid metal or tinted tempered glass panel • Equipment mounting rails are aluminum
Construction	Riveted and bolted
Finish	Powder coat paint Black or Glacier White

Space-Saving Design and Easy Access to Equipment

CUBE-iT Wall-Mount Cabinets feature highly functional elements to provide class-leading support and storage of ICT equipment. CUBE-iT Cabinets allow easy access to the front and rear of the cabinet, making it ideal for telecommunications rooms. Additionally, high airflow vent pattern and optional low-decibel, dual-fan kit provides equipment cooling without interfering noise. The new modern, sleek design with range of options make the cabinet ideal for use in office spaces, conference rooms, classrooms, or any public spaces where floor space is limited.

The swing-out, three-part design secures equipment while maintaining ease of access for serviceability. CUBE-iT Wall-Mount Cabinet is accessed by a keyed lock on the front door. Once unlocked, an internal latch is accessible just inside the front door on the main chassis. Simply turn the lever to release the main chassis from the wall to gain access to the rear of equipment. Additionally, the cabinet is configurable for right or left swing.

The cabinet body delivers exceptional strength and rigidity. The UL 2416 Listed 300 lb (136 kg) load-rating provides tested support for heavier equipment. For an updated look with a robust, high-quality viewing panel, the front door has an optional tempered glass window. Use CUBE-iT Wall-Mount Cabinet to meet growing demands, Power over Ethernet (PoE) deployments, faster wireless and premise networks, audio and video equipment, security and monitoring equipment and smart building initiatives.

The removable top and bottom rear panels feature a rectangular cable pass-through knockout with optional brush seals, providing a larger opening for cables that can accept patch panels, making CUBE-iT a great solution for retrofit and existing infrastructure, or for use with factory-terminated structured cabling.

CUBE-iT Wall-Mount Cabinet is available in three heights and three depths to support 12U, 19U or 26U of equipment.

RELATED ACCESSORIES

- Universal Cable Runway
- Rack-Mount Shelf
- Foot Kit for CUBE-iT Wall-Mount Cabinet
- Saf-T-Grip® Straps
- Horizontal Rack Busbar
- Horizontal Switched eConnect® PDU
- RIM-750
- Ground Jumper

DIMENSIONS:

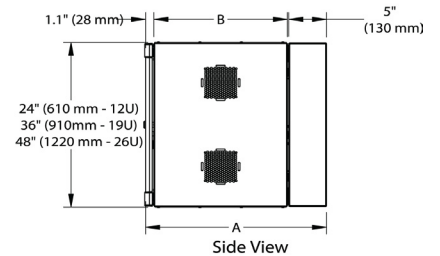
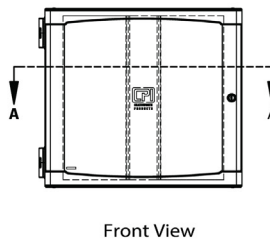
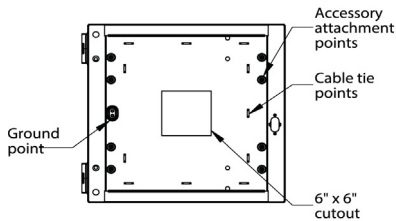
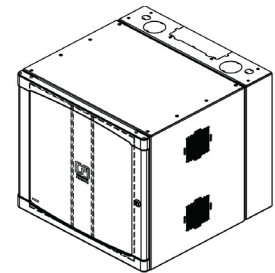
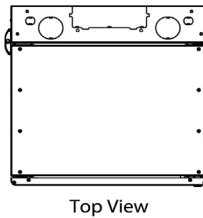
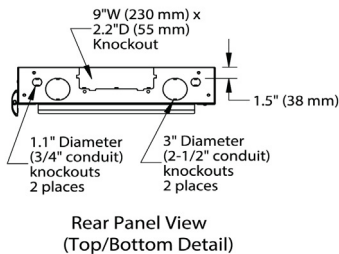

Rear Panel View (Interior Detail)

Front View

Side View

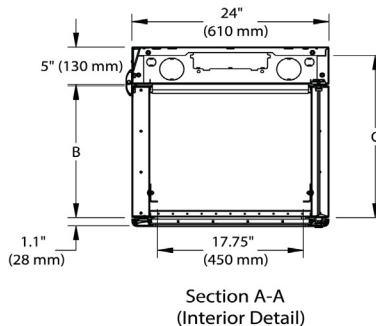

Section A-A (Interior Detail)

Depth		
Overall - A	Cabinet Body - B	Max. Equipment - C
18" (460 mm)	11.7 (297 mm)	15.9 (403 mm)
24" (610 mm)	17.7" (449 mm)	21.9" (556 mm)
30" (760 mm)	23.7" (602 mm)	27.9" (708 mm)

NOTE: Maximum equipment depth denotes values that still allow the center chassis to swing away from rear panel.

ORDERING INFORMATION:

CUBE-iT Wall-Mount Cabinets

- Attaches to the wall with included installation hardware
- Available in 12U, 19U and 26U heights, with solid metal or tempered glass door options
- All cabinet styles are 24"W (610 mm)
- Includes CH751 keyed lock

Part Number	Cabinet Depth	Door Style	Shipping Weight lb (kg)
24"H (610 mm) CUBE-iT Cabinet			
11890-X24	18" (460 mm)	Solid	90 (40.9)
11901-X24	18" (460 mm)	Tempered Glass	90 (40.9)
11840-X24	24" (610 mm)	Solid	101 (45.9)
11900-X24	24" (610 mm)	Tempered Glass	101 (45.9)
11996-X24	30" (760 mm)	Solid	112 (50.9)
12419-X24	30" (760 mm)	Tempered Glass	112 (50.9)
36"H (910 mm) CUBE-iT Cabinet			
11890-X36	18" (460 mm)	Solid	114 (51.8)
11901-X36	18" (460 mm)	Tempered Glass	114 (51.8)
11840-X36	24" (610 mm)	Solid	128 (58.2)
11900-X36	24" (610 mm)	Tempered Glass	128 (58.2)
11996-X36	30" (760 mm)	Solid	142 (64.5)
12419-X36	30" (760 mm)	Tempered Glass	142 (64.5)
48"H (1220 mm) CUBE-iT Cabinet			
11890-X48	18" (460 mm)	Solid	139 (63.2)
11901-X48	18" (460 mm)	Tempered Glass	139 (63.2)
11840-X48	24" (610 mm)	Solid	155 (70.5)
11900-X48	24" (610 mm)	Tempered Glass	155 (70.5)
11996-X48	30" (760 mm)	Solid	171 (77.7)
12419-X48	30" (760 mm)	Tempered Glass	171 (77.7)

Note: X=Color; 7=Black and E=Glacier White

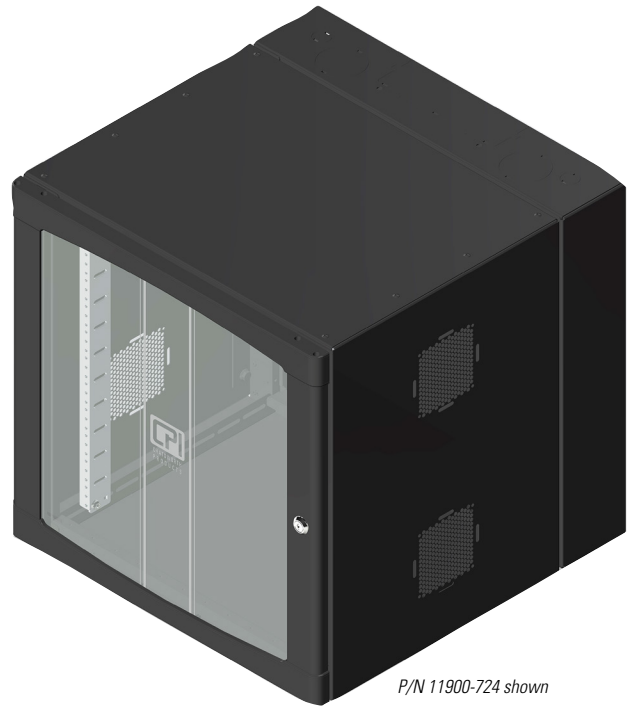

P/N 11900-724 shown

ACCESSORIES:

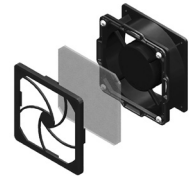

Standard Fan and Filter Kit for CUBE-iT Wall-Mount Cabinet

- Pressurizes interior of the cabinet, forcing warm air out of open vents
- Assembly Includes 1 fan, 1 filter, and 1 vent cover
- Noise Level: 39 dB (measured at 3' (1 m) distance)
- Airflow: 115 CFM (170 CMH)
- 6'L (1.8 m) NEMA 5-15P/6-15P Power Cord

Part Number	Description	Shipping Weight lb (kg)
40972-001	115 Volt, 50/60 Hz, 5-15P power cord	2 (0.8)
40972-002	230 Volt, 50/60 Hz, 6-15P Power cord	2 (0.8)
40973-001	Replacement Filter Kit, Pack of 5	2 (0.8)

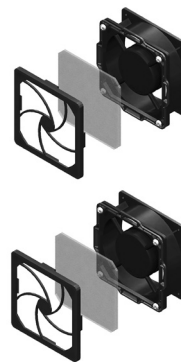

Low-Decibel Dual-Fan and Filter Kit for CUBE-iT Wall-Mount Cabinet

- Pressurizes interior of the cabinet, forcing warm air out of open vents
- Assembly Includes 2 fans and 2 filters
- Noise Level: 31 dB (measured at 3' (1 m) distance)
- Recommended placement on bottom right and left sides of the cabinet
- Airflow: 120 CFM (204 CMH)
- 6'L (1.8 m) NEMA 5-15P/6-15P Power Cord

Part Number	Description	Shipping Weight lb (kg)
40975-001	115 Volt, 50/60 Hz, 5-15P power cord	4 (1.8)
40975-002	230 Volt, 50/60 Hz, 6-15P Power cord	4 (1.8)
40973-001	Replacement Filter Kit, Pack of 5	2 (0.8)

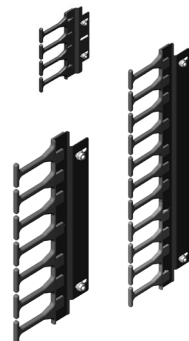

Vertical Cabling Section for CUBE-iT Wall-Mount Cabinet

- Attaches to the outside edge of equipment mounting rails
- 4U height; openings align with rack-mount unit spaces on equipment mounting rails
- Sold in pairs
- Order additional kits as-needed per cable management requirements

Part Number	Description	Shipping Weight lb (kg)
40970-704	4U, 7"H x 0.5"D (178 mm x 13 mm)	3 (1.4)
40970-707	7U, 12.3"H x 0.5"D (311 mm x 13 mm)	3 (1.4)
40970-711	11U, 19.3"H x 0.5"D (489 mm x 13 mm)	4 (1.8)

Color is black.



Vertical Lashing Bracket for CUBE-iT Wall-Mount Cabinet

- Provides multiple lashing points for premise cables
- Attaches to center chassis with included hardware
- Adjustable front-to-rear

Part Number	Description	Shipping Weight lb (kg)
40971-X24	24"H x 4"W (610 mm x 100 mm)	4 (1.8)
40971-X36	36"H x 4"W (910 mm x 100 mm)	6 (2.7)
40971-X48	48"H x 4"W (1220 mm x 100 mm)	8 (3.6)

Note: X=Color; 7=Black and E=Glacier White

ACCESSORIES:



Cable Port Brush Kit for CUBE-iT Wall-Mount Cabinet

- Optional cover when rectangular knockout on the rear panel is removed
- Seals opening around cables with brush seal
- Sold in pairs

Part Number	Description	Shipping Weight lb (kg)
25190-000	0.8"H x 10.6"W x 2.9"D (20 mm x 268 mm x 74 mm)	2 (0.9)



Horizontal Wire Management Bar for CUBE-iT Wall-Mount Cabinet

- Attaches to the rear of the equipment mounting rails
- Secures premise cables after termination on patch panels
- Includes mounting hardware and 12 cable ties

Part Number	Description	Shipping Weight lb (kg)
11837-701	1.5"H x 19.3"W x 3.7"D (38 mm x 490 mm x 94 mm)	4 (1.8)

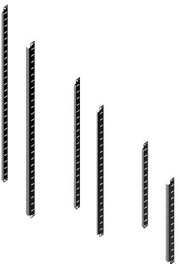

Equipment Mounting Rail Kit for CUBE-iT Wall-Mount Cabinet

- Use with equipment that needs front and rear support
- Sold in pairs
- Aluminum material

Part Number	Description	Shipping Weight lb (kg)
12787-524	12U; For 24"H (610 mm) cabinet	4 (1.8)
12787-536	19U; For 36"H (910 mm) cabinet	6 (2.7)
12787-548	26U; For 48"H (1220 mm) cabinet	8 (3.6)

Note: CUBE-iT Wall-Mount includes one pair of Equipment Mounting Rails

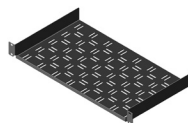

Rack-Mount Shelf

- For use with small equipment such as modems, routers and fiber modules in 19" EIA racks
- 1U; Includes multiples tie-down points
- Supports up to 20 lb (9.1 kg) of equipment

Part Number	Description	Shipping Weight lb (kg)
40974-X19	Rack-Mount Shelf, 1U x 19"W x 10"D (483 mm x 250 mm)	4 (1.8)

Note: X=Color; 7=Black and E=Glacier White

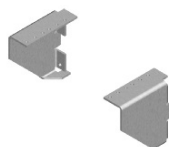

90° Mounting Bracket for CUBE-iT Cabinets

- Attaches to rear panel on CUBE-iT Cabinets
- Creates a 19" EIA x 2U vertical rack-mount space
- 2 brackets per kit, 3.9"H x 1"W x 4"D
(99 mm x 25.4 mm x 101.6)

Part Number	Description	Shipping Weight lb (kg)
13285-501	2U, 1 pair, Clear finish	3 (1.4)



Ground Jumpers

- Provide common bonding from equipment rack or cabinet to halo conductor
- Available individually or in packages of 10
- Constructed of UL Listed components

Part Number	Description	Shipping Weight lb (kg)
40159-009	9' (2.7 m) Ground Jumper, 1 Each	2 (0.9)
40159-019	9' (2.7 m) Ground Jumper, 10 Each	20 (1.9)



LED Light Kit for CUBE-iT Cabinets

- Attaches to the bottom, top or side of CUBE-iT Cabinets
- Toggle switch, 4W LED light
- Detachable, 120 VAC with NEMA 1-15P Power Cord

Part Number	Description	Shipping Weight lb (kg)
12803-701	LED Light Kit, 4W, 120 Vac	2 (0.9)



Power Strip for CUBE-iT Cabinets

- Select straight or locking plug style
- 115 VAC; 15 Amp or 20 Amp
- 10'L (3 m) power cord and circuit breaker
- Includes (8) 5-20R outlets

Part Number	Description	Shipping Weight lb (kg)
12820-701	15A Power Strip, NEMA 5-15P	4 (1.8)
12820-702	15A Power Strip, NEMA L5-15P	4 (1.8)
12820-705	20A Power Strip, NEMA 5-20P	4 (1.8)
12820-706	20A Power Strip, NEMA L5-20P	4 (1.8)

Note: Surge-protected options available



Foot Kit for CUBE-iT Wall-Mount Cabinet

- For use on desktops or floor when not installed on a wall
- Pack of 4

Part Number	Description	Shipping Weight lb (kg)
13483-001	Foot Kit	2 (0.9)



CPI now offers Extended Limited Warranties on CPI-Branded Electronic products, available for two additional years beyond the expiration of the Original Warranty Period (3 years).

Contact CPI Customer Service, or visit www.chatsworth.com/warranty for more information.

Interested in learning more about CUBE-iT Enclosure solutions? Call us at 800-834-4969, or email Technical Support at techsupport@chatsworth.com.



CHATSWORTH PRODUCTS

While every effort has been made to ensure the accuracy of all information, CPI does not accept liability for any errors or omissions and reserves the right to change information and descriptions of listed services and products. ©2018 Chatsworth Products, Inc. All rights reserved. Chatsworth Products, Click-Nut, CPI Passive Cooling, eConnect, Evolution, GlobalFrame, MegaFrame, OnTrac, QuadraRack, RMR, Saf-T-Grip, SeismicFrame, SlimFrame, TeraFrame and Velocity are federally registered trademarks of Chatsworth Products. CUBE-iT, EuroFrame, Motive, Secure Array and Simply Efficient are trademarks of Chatsworth Products. All other trademarks belong to their respective companies. Rev.11 02/18 MKI-60020-701